



---

# Electroluminescence from Single PVK Layer Organic Light Emitting Diode Using Different Dyes at Different Concentrations

Taher M. El-Agez<sup>1</sup>, Sofyan A. Taya<sup>1\*</sup>, Ahmed A. El Tayyan<sup>2</sup>,  
Monzir S. Abdel-Latif<sup>3</sup> and Ahed Afghjani<sup>1</sup>

<sup>1</sup>Department of Physics, Islamic University of Gaza, Gaza, Palestinian Authority.

<sup>2</sup>Department of Physics, Al Azhar University, Gaza, Palestinian Authority.

<sup>3</sup>Department of Chemistry, Islamic University of Gaza, Gaza, Palestinian Authority.

## Authors' contributions

*This work was carried out in collaboration between all authors. All authors read and approved the final manuscript.*

Research Article

Received 25<sup>th</sup> February 2013

Accepted 2<sup>nd</sup> May 2013

Published 24<sup>th</sup> May 2013

---

## ABSTRACT

In this work, organic light emitting diodes are fabricated using a single PVK layer doped with a dye. Three different dyes are used: crystal violet, fluorescein, and bromophenol blue. The structure of the single layer device is doped PVK sandwiched between indium tin oxide (ITO) and Indium-Gallium alloy (InGa) layers as anode and cathode, respectively. The I-V characteristic curves and electroluminescence emitted from the devices have been investigated in details with the concentration of the dyes. It is found that the threshold voltage after which the device begins to emit can be reduced by increasing the dye concentration up to 5%. It is found that devices fabricated using crystal violet and bromophenol blue dyes are more efficient than those fabricated using fluorescein dye. There is some preference of bromophenol blue dye over the crystal violet dye due to the smaller values of threshold voltages.

*Keywords: PVK; organic light emitting diode; electroluminescence.*

---

\*Corresponding author: Email: [staya@iugaza.edu.ps](mailto:staya@iugaza.edu.ps);

## 1. INTRODUCTION

Thin organic films have many attractive features and are being widely investigated for use in electronic devices. The major advantage of organic materials over inorganic semiconductors is that they can be deposited by evaporation, spin-coating, screen printing, and casting. These deposition methods are simpler and cheaper than most of those used in inorganic semiconductors.

Organic light emitting diodes (OLEDs) are solid state light-emitting devices. The light emitted by an OLED is generated through the process of electroluminescence. This phenomenon arises from the recombination of electron-hole that occurs upon applying a voltage to semiconductor materials sandwiched between two electrodes. The semiconductor materials are deposited in OLEDs as single or multiple layers. Such layers are usually hole-transporting, emissive, and electron-transporting layers. When a voltage is applied to an OLED, electrons are injected from the cathode into the electron-transport layer, while holes are injected into the hole-transport layer. The charge carriers travel through the respective transport layers until they recombine and produce excitons, which then annihilate releasing energy in the form of light.

Over the last two decades, there have been many advances in OLEDs research and technology including the development of new materials and the optimization of device architectures. Among the attractive characteristics of OLEDs are the high brightness, fast response time, low operating voltage, and wide viewing angles [1-3].

The first efficient devices were fabricated using fluorescent organic emitters such as tris-(8-hydroxyquinoline) aluminum (Alq3) [4]. In these OLEDs only the singlet excitons contributed to the light output. Theoretical estimations predict the formation of 1 singlet exciton for each 3 triplet excitons. Thus, the theoretical limit for fluorescence-only devices is a 25% theoretical internal efficiency [5-7].

Poly(9-vinylcarbazole) (PVK) is a well known polymer for its photoconducting properties [8-10]. It exhibits photoluminescent properties in the UV region [11-13]. A variety of organic materials including polymers, metal complexes, and dyes have demonstrated strong electroluminescence. The efficiency of an OLED strongly depends on the choice of molecules and on the design of the device structure [14-17]. The electroluminescence from single layer thin films devices of PVK doped with Bu-PBD and variety of emitter molecules was presented by Johnson et al [18]. In 2002, the electroluminescence properties of some dyes in a single-layer device having the following structure: ITO/PVK:DYE/Ca/Al has been reported [19]. They found that both the wavelength of maximum emission and the threshold of electroluminescence depend on the structure and the concentration of the dye. In a recent study, the electroluminescence from devices composed of a single PVK layer doped with an organic material has been studied [20]. They used two new triazole derivatives and a new oxadiazole derivative. Our main objective is to fabricate simple single-layer OLED with low threshold voltage.

In this paper, we report electroluminescence from a device composed of a single PVK layer doped with one of three different dyes: crystal violet ( $C_{25}N_3H_{30}Cl$ ), fluorescein ( $C_{20}H_{12}O_5$ ), and bromophenol blue ( $C_{19}H_{10}Br_4O_5S$ ). These dyes have been selected because they are electroluminescent. The effect of the dye concentration on the I-V characteristic curves and on the electroluminescence emitted from the samples is investigated. The structures of PVK and the organic dyes are shown in Fig. 1.

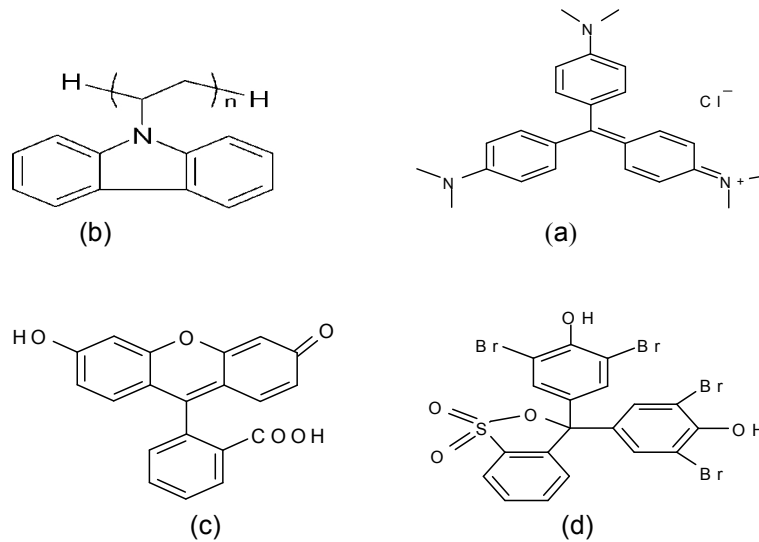

**Fig. 1. The structures of (a) PVK, (b) Crystal violet dye, (c) Fluorescein dye (d) and Bromophenol blue dye**

## 2. EXPERIMENTALS

### 2.1 Sample Preparation

Poly(9-vinylcarbazole) PVK (Sigma-Aldrich, USA) with an average molecular weight of  $11 \times 10^5$  was used in this work. A desired amount of PVK was dissolved in a proper amount of mixed solvents of toluene and tetrahydrofuran THF. A certain amount of dye dissolved in THF was then added to the PVK solution. A homogeneous blend solution was then obtained by stirring. The solution was then deposited on the transparent conducting electrodes (ITO coated glass substrates purchased from Delta Technologies, USA) to form a thin film with a thickness of about 44 nm. The thickness was measured using a home-made rotating polarizer analyzer ellipsometer with a speed ratio 2:1 [21]. Several concentrations of each dye were used (1% to 5% by weight). Table 1 shows the details of the ITO/PVK/InGa and ITO/blend of PVK and crystal violet/InGa devices. Other devices corresponding to fluorescein and bromophenol blue dyes are prepared with the same weights and concentrations. It is worth to mention that all samples have almost the same thickness of about 44 nm.

**Table 1. The structure of PVK-dye blend devices**

Structure	Dye solution	Polymer solution	Dyeconcentration (by weight)
ITO/ PVK /InGa	-	15mg PVK+1ml toul+5ml THF	0%
ITO/blend of PVK and crystal violet/InGa	1ml THF+0.15mg crystal violet	15mg PVK+1ml toul+4ml THF	1%
	1ml THF+0.30mg crystal violet		2%
	1ml THF+0.45mg crystal violet		3%
	1ml THF+0.60mg crystal violet		4%
	1ml THF+0.75mg crystal violet		5%

Thin films from blend solutions were obtained by placing a small amount of the desired solution on the substrate. The substrate was inclined at an angle of 45° for several minutes. The solution spreads on the surface of the substrate due to gravity forming a thin film on the surface. The sample is then placed in an oven at 60°C in order to remove the residual solvents. The thickness can be increased by increasing the concentration of the polymer in the solution and vice versa. This process is sensitive to the variations in temperature due to different evaporation rates of solvents.

Fig. 2 shows a schematic diagram of the single layer device (ITO/ blend of PVK and a dye/InGa). As mentioned above, three dyes were used: crystal violet, bromophenol blue and fluorescein.

Eutectic Gallium-Indium (EGaIn) is a mixture of gallium (Ga) and indium (In), typically 75% Ga, 25% in by weight. The melting point of EGaIn is 15.5°C. EGaIn is electrically conductive with resistivity  $\sim 24.4 \times 10^{-6} \Omega \cdot \text{cm}$ ; this property allows EGaIn to be used as a contact electrode for the electrical characterization of thin film organic and semiconductor devices. The work function of EGaIn is about (4.1- 4.2) eV [22,23]. The EGaIn drop diameter was 2 mm for all devices.

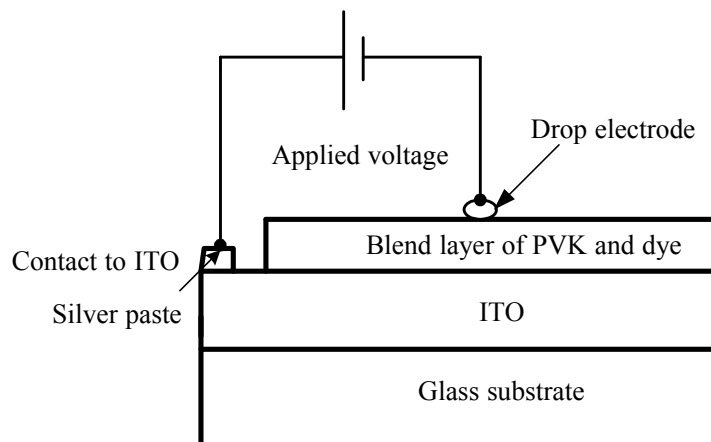
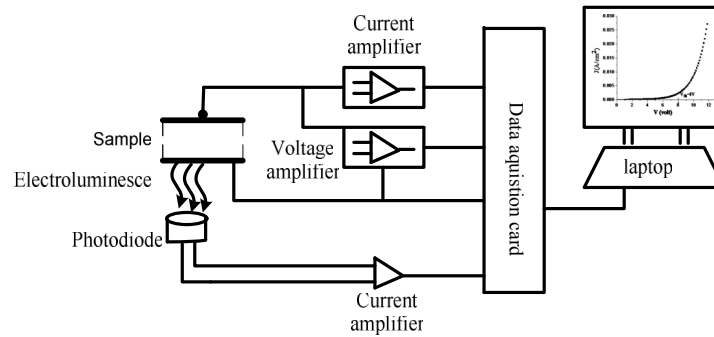

Fig. 2. Schematic drawing of the single layer device

## 2.2 Electrical Measurements

The voltage-current signals were applied and recorded through NI USB-6251 data acquisition card, which is a high speed, multifunction analog/digital I/O expansion board that turns a host computer into accurate data-acquisition card and signal analysis instrument. This card is used to control and measure the voltage across the sample and the current flowing through it as well as to record the photocurrent. Fig. 3 shows the experimental setup used in the measurements.

During the measurements, the EInGa electrode was negatively biased whereas the transparent electrode ITO was positively biased. All samples are biased over the range of voltages from 0 to 16 volt. Electrical measurements were carried out at room temperature. The light intensity emitted from the samples was measured using a photodiode. The output of the photodiode was amplified then collected by the same data acquisition card.



**Fig. 3. The experimental setup used in measurements**

### 3. RESULTS AND DISCUSSIONS

Sixteen different devices have been prepared and studied. In the following, the experimental results are presented. These results include the current-voltage characteristics, current-voltage relation in logarithmic scale, and light intensity with the applied voltage and the current.

#### 3.1 Characteristic Curves

The currents flowing through the samples are attributed to the injection of charges from the metallic electrodes. Figs. 4.a, 5.a, and 6.a illustrate the J-V characteristic curves for samples doped with crystal violet, fluorescein, and bromophenol blue dyes, respectively. It is clear that the J-V characteristic curves show nonlinearity for all samples. The J-V characteristics exhibit almost an exponential increase of the current with the applied voltage in many samples which is similar to a typical diode characteristic curve. The current density increases slowly with increasing voltage. At certain higher voltage (threshold voltage  $V_{th}$ ) the current density increases sharply. For other samples, sharp increase of current density at low applied voltage can be seen. This increase in the current density may be attributed to leakage current which is linearly dependent on the applied voltage. The leakage current may be attributed to the movement of charge carriers from the blend layer towards the ITO electrode. Most of samples, especially those doped with crystal violet and bromophenol, show an increase in the current density and a decrease in the threshold voltage when increasing the concentration of the dye. One of our objectives in this work is to find a simple device structure with a low threshold voltage. Our devices show lower threshold voltages than the threshold voltage (18 V) reported in Ref. [24] for Alq<sub>3</sub>/PVK OLED.

The emission regime associated with electroluminescence was detected in thirteen samples. Only the devices doped with fluorescein dye at concentrations of 3%, 4% and 5% are observed to give no electroluminescence. The variations of the electroluminescence with applied voltage are shown in Figs. 4.b, 5.b, and 6.b. At low forward bias voltage, there is no electroluminescence. The luminescent samples start emitting light at the threshold voltage. The light intensity increases rapidly with increasing the forward bias voltage when the applied voltage exceeds  $V_{th}$ . The threshold voltage of a device which is a crucial parameter in the field of OLEDs can be estimated from the light intensity-voltage characteristics curves. The value of  $V_{th}$  for the devices at various dyes concentrations are shown in Table 2. The value of  $V_{th}$  for a device with pure PVK is found to be 9.5 volt. As can be seen from the table,

there is a significant decrease in the threshold voltage when the dye concentration increases especially in the samples dyed with crystal violet and bromophenol blue dyes. Moreover, we have noticed that increasing the concentration more than 5% yields high leakage current and thermal dissipation in devices dyed with crystal violet and bromophenol blue whereas devices dyed with fluorescein do not exhibit electroluminescence after 3% concentration. We may conclude that devices fabricated using crystal violet and bromophenol blue dyes are more efficient than those fabricated using fluorescein dye in the range of concentrations considered with some preference of bromophenol blue dye over the crystal violet dye due to the smaller values of threshold voltages.

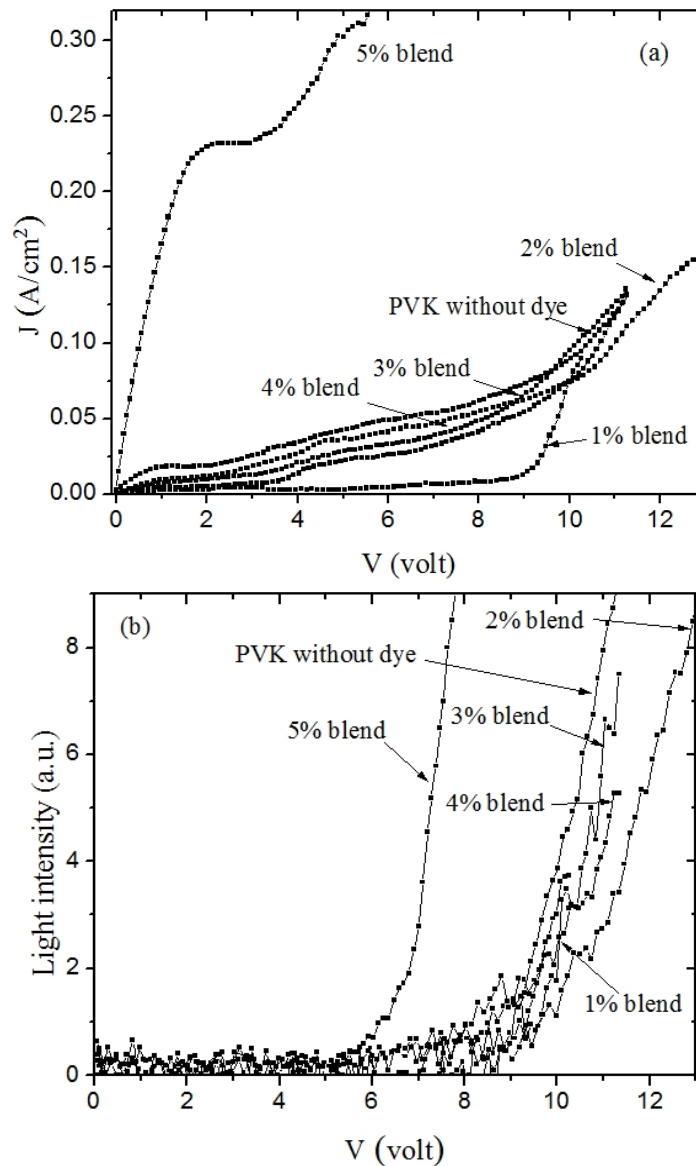

**Fig. 4. Characteristics curves of ITO/crystal violet-PVK blend /InGa. (a) current density-voltage characteristics and, (b) light intensity-voltage characteristics**

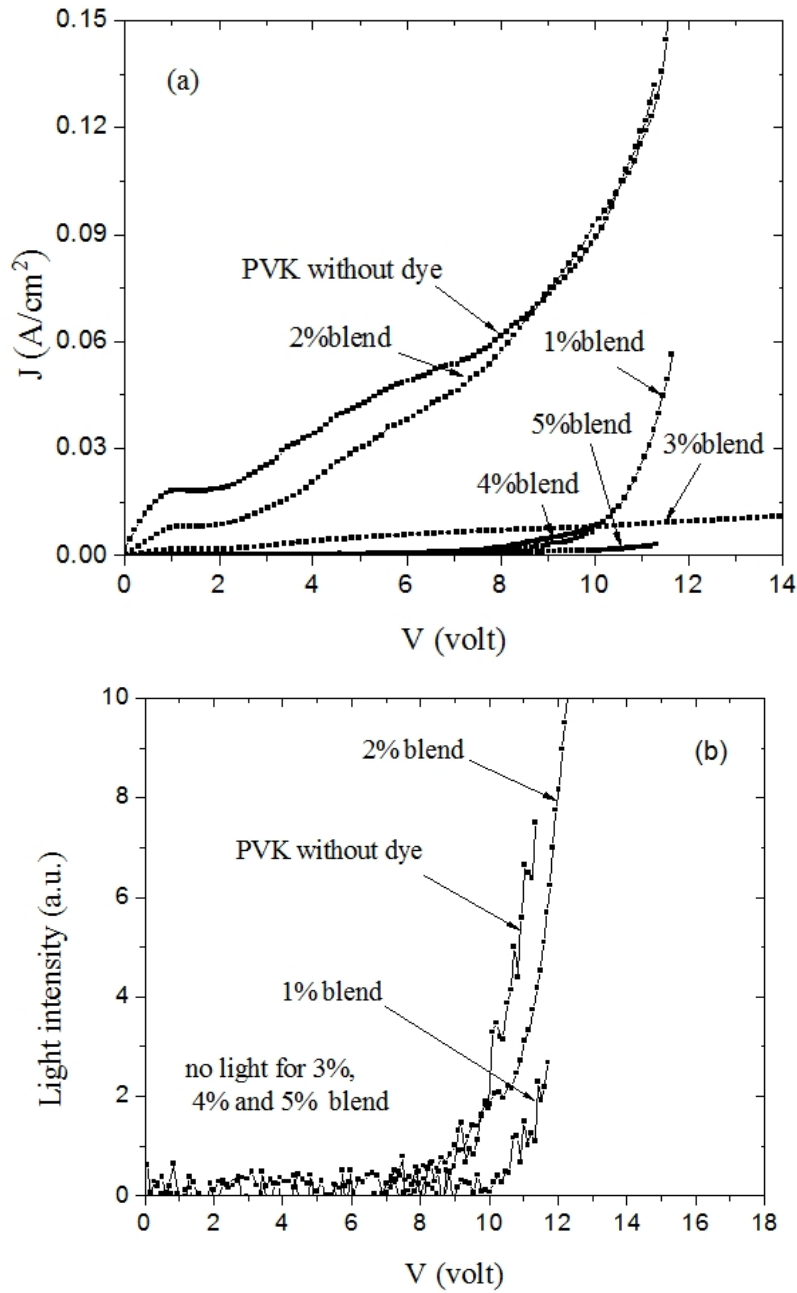

Fig. 5. Characteristics curves of ITO/Fluorescein-PVK blend /InGa. (a) current density-voltage characteristics and, (b) light intensity-voltage characteristics

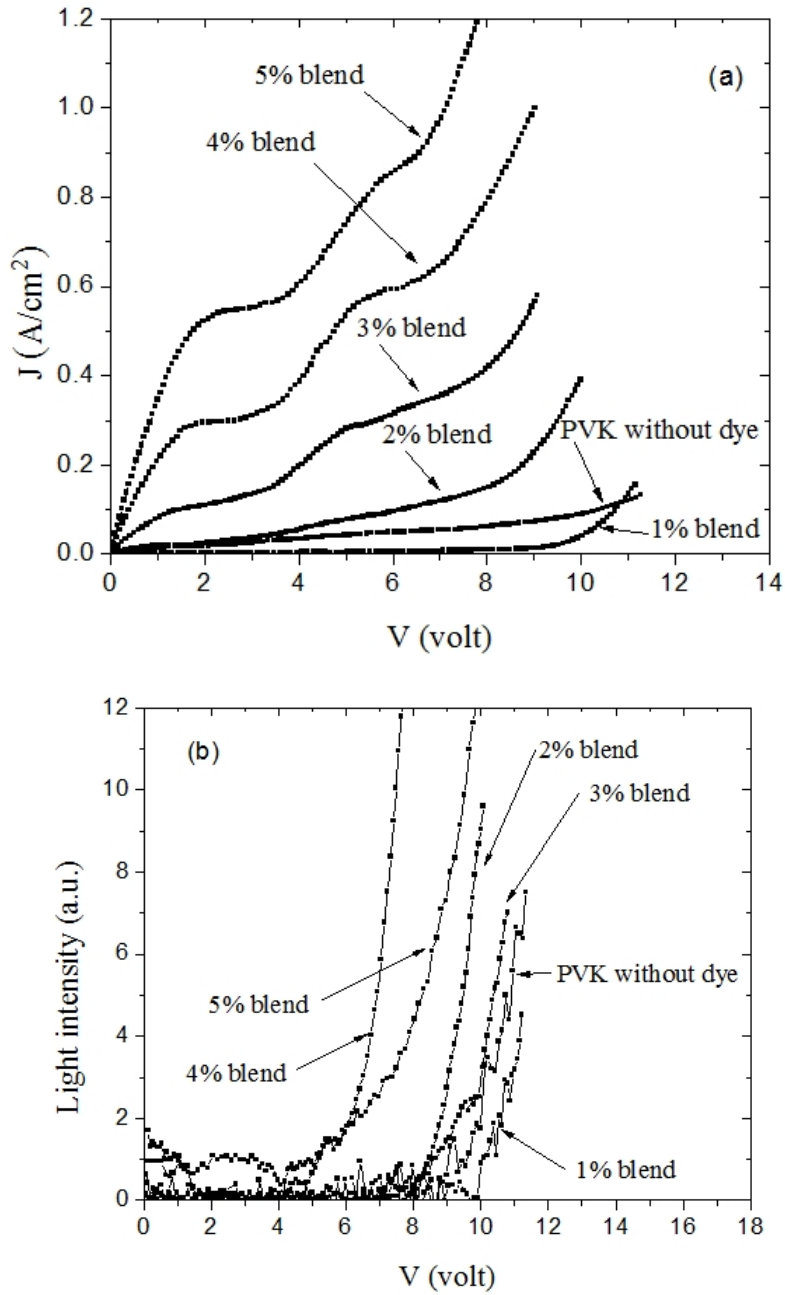

Fig. 6. Characteristics curves of ITO/Bromophenol blue-PVK blend /InGa. (a) current density-voltage characteristics and, (b) light intensity-voltage characteristics

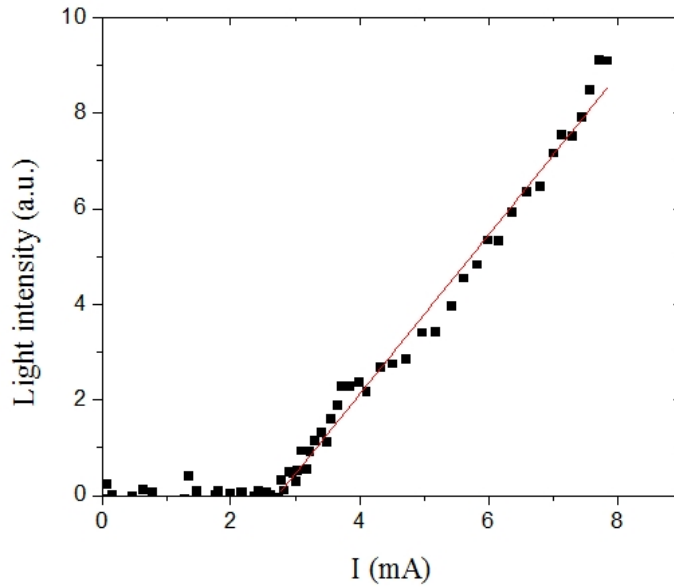

**Table 2. The threshold voltages for the fabricated devices at various dyes concentrations**

Dye concentration	Threshold voltage $V_{th}$ (Volt)		
	Crystal violet dye	Fluorescein dye	Bromophenol blue dye
1%	9	10	10
2%	8.8	8	8
3%	7.5	-	7
4%	7	-	6
5%	6	-	5

### 3.2 Light Intensity with Current

Figs. 7 and 8 illustrate the light intensity versus the current for two samples doped with crystal violet and bromophenol blue at concentration of 2% by weight. It is clear that the curves show linear relationship between the intensity of emitted light and the current. Other samples dyed at different concentrations have shown a similar behavior.



**Fig. 7. Light intensity-current characteristics curve for the 2% crystal violet-PVK blend sample**

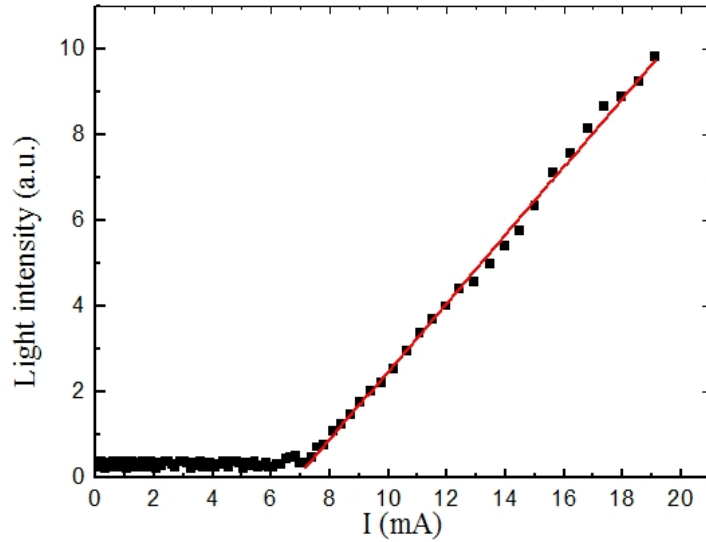

**Fig. 8. Light intensity-current characteristics curve for the 2% bromophenol blue -PVK blend sample**

### 3.3 Conduction Mechanisms

One can study the conduction mechanisms using J-E or J-V curves. Sometimes, the J-E curves are preferred since the J-V curves depend on the thickness of the films. In our study, the thickness of all devices was almost constant so we can adopt the J-V curves as in Ref. [25-27]. Figs. 9 and 10 show the dependence of the natural logarithm of current density  $J$  on the natural logarithm of voltage  $V$  for two devices doped with 2% dye. These curves exhibit nonlinear relationship and can be divided into three to four regions as AB, CD, DE, and EF. As can be seen from the two figures, between two consecutive regions, sometimes, another region appears. For example, region BC appears between regions AB and CD. This region may correspond to some small transition region from one physical process to another one. These different regions have different slopes which indicate that the J-V relation (in the natural logarithmic scale) have the form  $J \propto V^s$  where  $s$  is the slope of the curve. At low voltages, the  $\ln J$ - $\ln V$  characteristic curves show slopes for region AB to be very close to unity in many samples. This means that the conduction in this region follows Ohm's law which is given by the following equation

$$J_{ohm} = qn\mu \frac{V}{d}, \tag{1}$$

where  $q$  is the electronic charge,  $n$  is the charge carriers density,  $\mu$  is the carriers mobility and  $d$  is the thickness. Therefore, the conduction mechanism is ohmic in this region. This is the case for most samples. As the voltage increases further, the slope ranges between 0.5 and 5.2 in the region CD. In many samples it is nearly equal to 2 as shown in Table 3. In this case, the region obeys Child's law given by the following equation

$$J_{SCL} = \frac{9}{8} \mu \epsilon \frac{V^2}{d^3}, \tag{2}$$

where  $\epsilon$  is the permittivity of the medium. In these regions, the conduction becomes space charge limited (SCL). As the voltage increases, the two above conduction mechanisms are repeated, that means the occurrence of the SCL conduction mechanism breakdown and the emergence of another dominating conduction mechanism in which the slope can reach to 4 and 5. All these results are presented in Table 3.

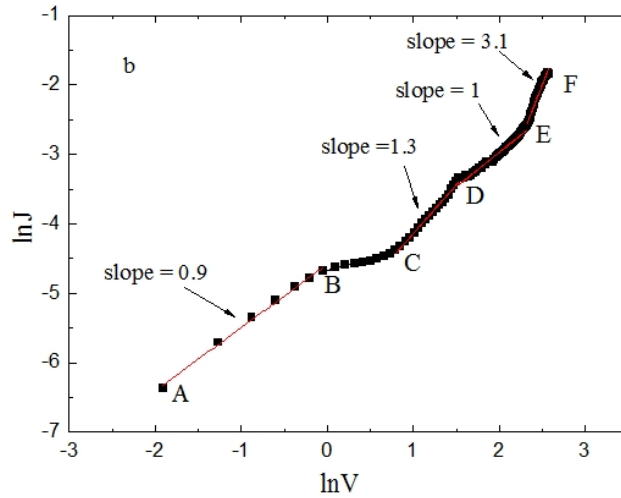

**Fig. 9. Characteristics curve in logarithmic scale for the 2% crystal violet-PVK blend sample**

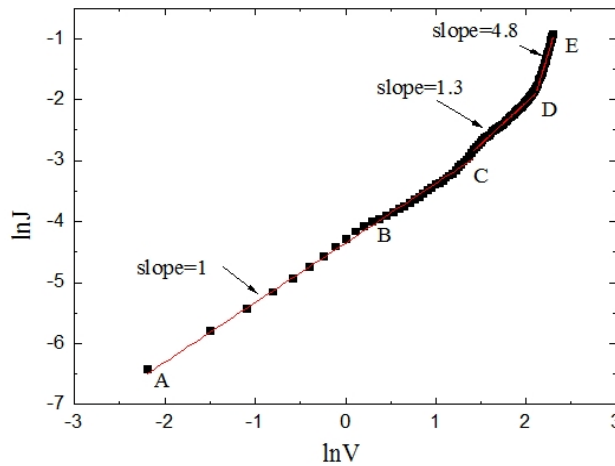
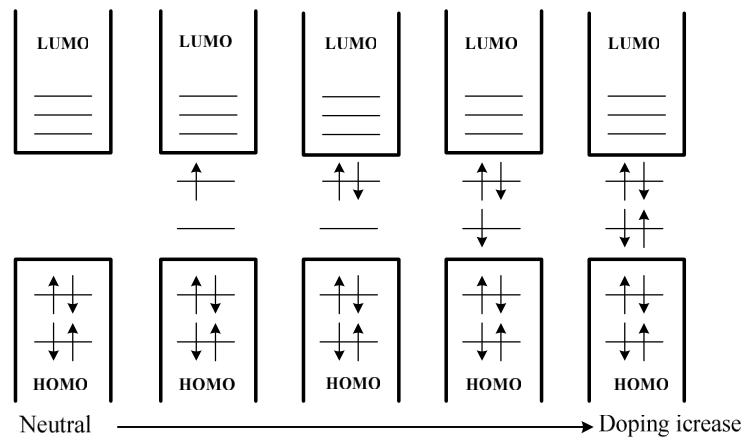

**Fig. 10. Characteristics curve in logarithmic scale for the 2% bromophenol blue-PVK blend sample**

**Table 3. Experimental values of slopes for each region of the InJ-InV characteristic curves**

Dye	Dye concentration	AB	CD	DE	EF
Pure PVK	0%	0.6	0.9	2	
	1%	0.9	2.1	15	
Crystal Violet Dye	2%	0.9	1.3	1	3.1
	3%	0.8	0.87	4.4	1.2
	4%	0.8	1.8	1	3
	5%	0.8	0.5	1	
	1%	1	2.8	10	
Fluorescein Dye	2%	1	1.5	2	5
	3%	1.2	1.3	0.7	
	4%	0.7	5.2		
Bromophenol Blue Dye	5%	2	2.5		
	1%	0.8	1.7	12	
	2%	1	1.3	4.8	
Blue Dye	3%	0.7	1.7	0.9	
	4%	0.7	1.2	0.3	1.6
	5%	0.8	1	0.5	1.8

The repetition of conduction mechanisms is attributed to the following: After domination for a voltage interval, SCL collapses and turns to ohmic conduction mechanism in which a slight increase of the current with V is observed. This can be attributed to the presence of traps inside the blend of PVK film. When the SCL dominates, the current is observed to increase sharply with V (high slope to J-V curve is observed). This sharp increase is due to filled traps. At a certain value of V the trapped electron gains energy that is sufficient to get free from its trap. This process is called Pool-Frenkel emission. Any further increase in V results in increasing the injection of the charge carriers, but some of these carriers are trapped which explains the breakdown of SCL conduction mechanism. Finally, it is worth to mention that in region where the slope reaches 4-5 after SCL conduction regions, all the traps are completely filled. Fig. 11 shows the energy band diagram for the polymer at neutral and at different doping.



**Fig. 11. The energy band diagram for the polymer at neutral and different doping**

As indicated before, as doping increases the threshold voltage decreases. This can be attributed to the existence of impurity levels (electrons or holes) in the energy gap. When the electronic wave functions of impurity state overlap, an electron bound to one impurity state can tunnel to an unoccupied impurity state. This tunneling process between impurity sites is referred to as impurity conduction [28].

#### **4. CONCLUSION**

We have investigated the electroluminescence from devices composed of a single PVK layer doped with crystal violet dye, fluorescein dye, and bromophenol blue dye. The fabricated devices are composed of single doped PVK layer sandwiched between indium tin oxide (ITO) and Indium-Gallium alloy (InGa) layers as electrodes. The I-V characteristic curves of most samples are found to be similar to that of a typical diode. The electroluminescence emitted from these devices has been investigated with applied voltage. The threshold voltages of all devices have been determined and are found to decrease by increasing the dye concentration up to 5%. It is found that increasing the dye concentration more than 5% yields high leakage current and thermal dissipation in devices dyed with crystal violet and bromophenol blue. Devices dyed with fluorescein do not exhibit electroluminescence after 3% concentration. The results revealed that devices fabricated using crystal violet and bromophenol blue dyes are more efficient than those fabricated using fluorescein dye in the range of concentrations considered with some preference of bromophenol blue dye over the crystal violet dye due to the smaller values of threshold voltages. The conduction mechanism in these devices is studied and explained. More work is needed to improve the performance of these devices by incorporating additional electron transport layers as well as buffer layers.

#### **COMPETING INTERESTS**

Authors have declared that no competing interests exist.

#### **REFERENCES**

1. Jenekhe SA. The special issue on Organic Electronics. *Chem. Mater.* 2004;16:4381.
2. Kraft A, Grimsdale AC, Holmes AB. *Angew. Electroluminescent Conjugated Polymers—Seeing Polymers in a New Light*, Chem., Int. Ed. 1998;37:402.
3. Friend RH, Gymer RW, Holmes AB, Burroughes JH, Marks RN, Taliani C, Bradley DDC, Dos Santos DA, Brédas JL, Logdlun M, Salaneck W R. Electroluminescence in conjugated polymers, *Nature.* 1999;397:121.
4. Tang C, VanSlyke S. Organic electroluminescent diodes, *Appl. Phys. Lett.* 1987;51:913.
5. Kafafi ZH. *Organic electroluminescence*. CRC Press: Boca Raton, FL; 2005.
6. Shinar J. *Organic Light-Emitting Devices-A Survey*. Springer-Verlag: Berlin; 2003.
7. Kelly SM. In *Flat Panel Displays. Advanced Organic Materials: Connor J. A. Series Ed.* Royal Society of Chemistry: Cambridge, U.K.; 2000.
8. Chen Y, Cai RF, Xiao LX. Synthesis and characterization of photoconductive C-60-N-vinylcarbazole copolymers, *J. Mat. Science.* 1998;33(18):4633-4641.
9. Kaczmarek M, Dyadusha A, Slussarenko S, Optimization of liquid crystal structures for real time holography applications, Khoo IC. *J. Appl. Phys.* 2004;96(5):2616-2623.

10. Li F, Li Y, Guo Z, Long C, Bai F, Zhu D, Photoconductivity of 1,2-(1',1',2',2'-tetracyanomethoxymethano)[60] fullerene-doped PVK, *J. Appl. Polym. Science*. 1999;72(2):209-213.
11. Burroughes JH, Bradley DDC, Brown AR, Marks RN, Mackay K, Friend RH, Burns PL, Holms AB. Light-emitting diodes based on conjugated polymers, *Nature*. 1990;347:539-541.
12. Braun D, Heeger AJ. Visible light emission from semiconducting polymer diodes, *Appl. Phys. Lett.* 1991;52:1982.
13. Jonda C, Mayer ABR. Investigation of the Electronic Properties of Organic Light-Emitting Devices by Impedance Spectroscopy, *Chem. Matter*. 1999;11:2429-2435.
14. Razavi H, Mohajerani E, Safari N, Shahroosvand H, Khabbazi A, Electroluminescence and photoluminescence in porphyrin derived compounds in a new polymeric PVK:PBD host, *J. Porphyrins Phthalocyanines*. 2012;16:396.
15. Glowacki I, Szamel Z, The nature of trapping sites and recombination centres in PVK and PVK-PBD electroluminescent matrices seen by spectrally resolved thermoluminescence, *J. Phys. D: Appl. Phys.* 2010;43(29):295101.
16. Kido J, Hongawa K, Nagai K, Okuyama, Charge transport polymers for organic electroluminescent devices, *Macromolecular Symposia* 2011;84(1):81.
17. Ye T, Chen J, Ma D, Electroluminescence of poly(N-vinylcarbazole) films: fluorescence, phosphorescence and electromers, *Phys. Chem. Chem. Phys.* 2010;12:15410.
18. Johnson G, McGrane K, Stolka M, Electroluminescence from single layer molecularly doped polymer films, *Pure & Appt. Chem.* 1995;67:175.
19. Patra A, Pan M, Friend CS, Lin TC, Cartwright AN, Prasad PN, Burzynski R. Electroluminescence Properties of Systematically Derivatized Organic Chromophores Containing Electron Donor and Acceptor Groups, *Chem. Mater.* 2002;14:4044.
20. El Tayyan AA, El-Agez TM, Abdel-Latif MS. Electroluminescence from Single Layer Poly(N-vinylcarbazole) Films Doped with New Emitter Molecules, *Chinese J. Phys.* 2008 46:153.
21. El-Agez T, Taya SA. Development and construction of rotating polarizer analyzer ellipsometer. *Optics and lasers in engineering*. 2011;49:507-513.
22. Dickey M, Chiechi R, Larsen R, Weiss E, Weitz D, Whitesides G. Eutectic Gallium-Indium (EGaIn): A Liquid Metal Alloy for the Formation of Stable Structures in Microchannels. *Adv. Funct. Mater.* 2008;18:1097-1104.
23. Chiechi R, Weiss E, Dickey M, Whitesides G. Eutectic Gallium-Indium (EGaIn): A Moldable Liquid Metal for Electrical Characterization of Self-Assembled Monolayers. *Angew. Chem. Int. Ed.* 2008;47:142-144.
24. Michelotti F, Borghese F, Bertolotti M, Cianci E, Foglietti V, Alq/PVK heterojunction electroluminescent devices. *Synthetic Metals*. 2000;111-112:105-108.
25. Laubender J, Chkoda L, Sokolowski M, Umbach E. The influence of oxygen and air on the characteristics of organic light-emitting devices studied by in vacuo measurements. *Synthetic metals*. 2000;111-112:373.
26. Dongge Ma, Hümmelgen I. Charge carrier mobility and electroluminescence in a green-emitting alternating block copolymer with a methoxy bi-substituted chromophore. *Braz. J. Phys.* 2000;30:392.
27. Safoula G, Napo K, Bernède JC, Touihri S, Alimi K, Electrical conductivity of halogen doped poly-(N-vinylcarbazole) thin films, *European Polymer J.* 2001;37:843.

28. Kao K. Dielectric phenomena in solids with emphasis on physical concepts of electronic processes. Elsevier Academic Press: California; 2004.

---

© 2013 El-Agez et al.; This is an Open Access article distributed under the terms of the Creative Commons Attribution License (<http://creativecommons.org/licenses/by/3.0>), which permits unrestricted use, distribution, and reproduction in any medium, provided the original work is properly cited.

*Peer-review history:*

*The peer review history for this paper can be accessed here:*

*<http://www.sciencedomain.org/review-history.php?iid=224&id=4&aid=1406>*